

NPN SILICON POWER TRANSISTOR 2SC2333

DESCRIPTION The 2SC2333 is NPN silicon triple diffused transistor designed for switching regulator, DC-DC converter and ultrasonic appliance applications.

- FEATURES**
- High speed switching.
 - Low collector saturation voltage.
 - Specified of reverse biased SOA with inductive loads.

ABSOLUTE MAXIMUM RATINGS

Maximum Temperatures	
Storage Temperature	-55 to +150 °C
Junction Temperature	150 °C Maximum
Maximum Power Dissipation (T _c = 25 °C)	
Total Power Dissipation	15 W
Maximum Voltages and Currents (T _a = 25 °C)	
V _{CBO} Collector to Base Voltage	500 V
V _{CEO} Collector to Emitter Voltage	400 V
V _{EBO} Emitter to Base Voltage	7.0 V
I _{C(DC)} Collector Current (DC)	2.0 A
I _{C(pulse)} Collector Current (pulse)*	4.0 A
I _{B(DC)} Base Current (DC)	1.0 A

* PW ≤ 350 μs, Duty Cycle ≤ 10 %

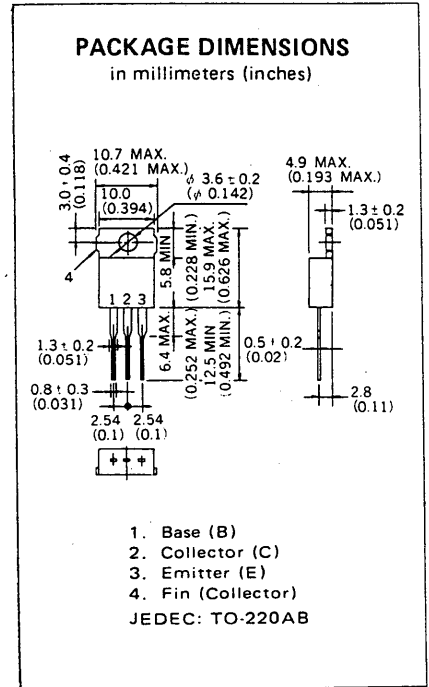

ELECTRICAL CHARACTERISTICS (T_a = 25 °C)

SYMBOL	CHARACTERISTIC	MIN.	TYP.	MAX.	UNIT	TEST CONDITIONS
t _{on}	Turn On Time			1.0	μs	I _C = 0.5 A, I _{B1} = -I _{B2} = 0.1 A R _L = 300 Ω, V _{CC} = 150 V See Test Circuit.
t _{stg}	Storage Time			2.5	μs	
t _f	Fall Time			1.0	μs	
h _{FE1}	DC Current Gain**	20		80	-	V _{CE} = 5.0 V, I _C = 0.1 A
h _{FE2}	DC Current Gain**	10			-	V _{CE} = 5.0 V, I _C = 0.5 A
V _{CE(sat)}	Collector Saturation Voltage**			1.0	V	I _C = 0.5 A, I _B = 0.1 A
V _{BE(sat)}	Base Saturation Voltage**			1.2	V	I _C = 0.5 A, I _B = 0.1 A
V _{CEO(SUS)}	Collector to Emitter Sustaining Voltage	400			V	I _C = 0.5 A, I _B = 0.1 A, L = 1 mH
V _{CEx(SUS)1}	Collector to Emitter Sustaining Voltage	450			V	I _C = 0.5 A, I _{B1} = -I _{B2} = 0.1 A, T _a = 125 °C, L = 180 μH, Clamped
V _{CEx(SUS)2}	Collector to Emitter Sustaining Voltage	400			V	I _C = 1.0 A, I _{B1} = 0.2 A, -I _{B2} = 0.2 A, T _a = 125 °C, L = 180 μH, Clamped
I _{CBO}	Collector Cutoff Current			10	μA	V _{CB} = 400 V, I _E = 0
I _{CER}	Collector Cutoff Current			1.0	mA	V _{CE} = 400 V, R _{BE} = 51 Ω, T _a = 125 °C
I _{CEx1}	Collector Cutoff Current			10	μA	V _{CE} = 400 V, V _{BE(OFF)} = -5.0 V
I _{CEx2}	Collector Cutoff Current			1.0	mA	V _{CE} = 400 V, V _{BE(OFF)} = -5.0 V, T _a = 125 °C
I _{EBO}	Emitter Cutoff Current			10	μA	V _{EB} = 5.0 V, I _C = 0

**Pulse Test : PW ≤ 350 μs, Duty Cycle ≤ 2 %/Pulsed

Classification of h_{FE1}

Rank	M	L	K
Range	20 to 40	30 to 60	40 to 80

Test Conditions : V_{CE} = 5.0 V, I_C = 0.1 A

TYPICAL CHARACTERISTICS ($T_a = 25^\circ\text{C}$)

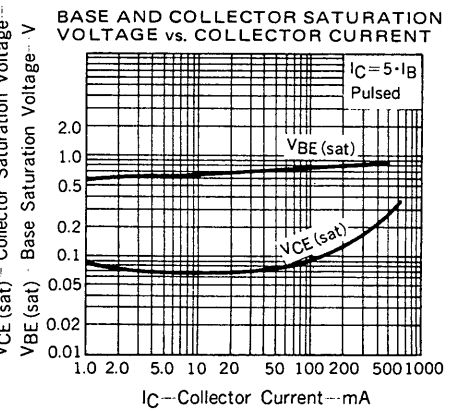
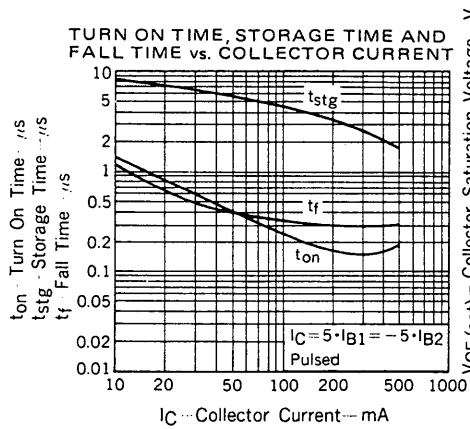
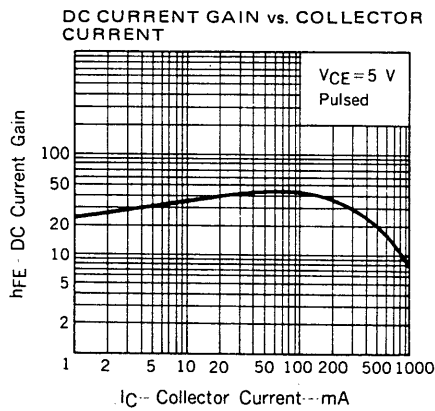
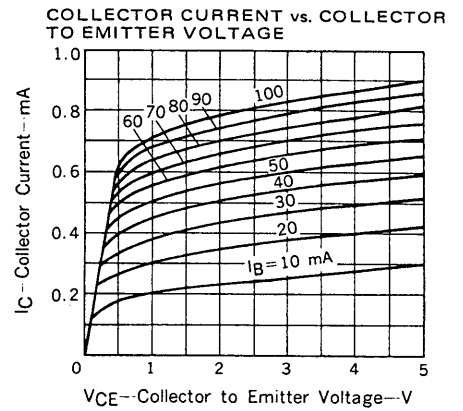
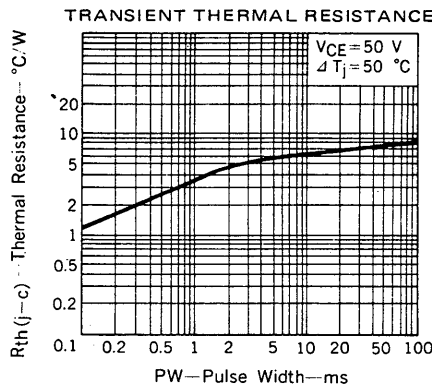
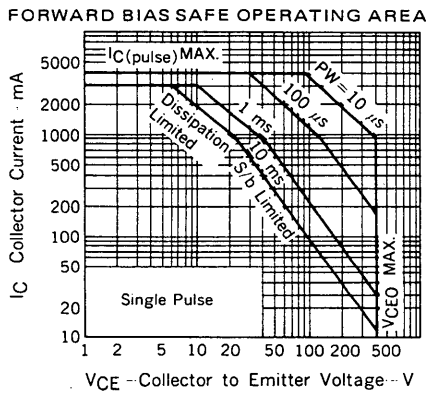
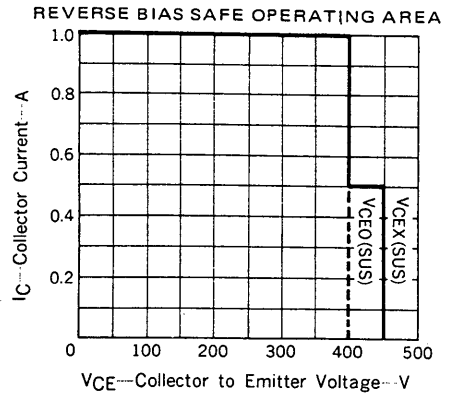
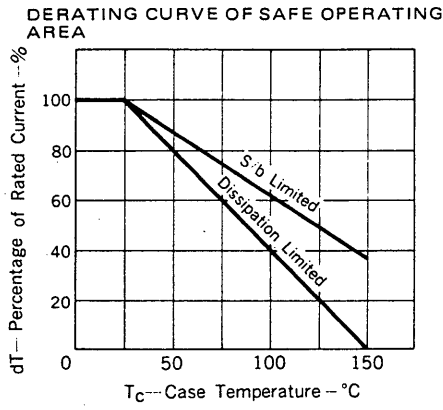
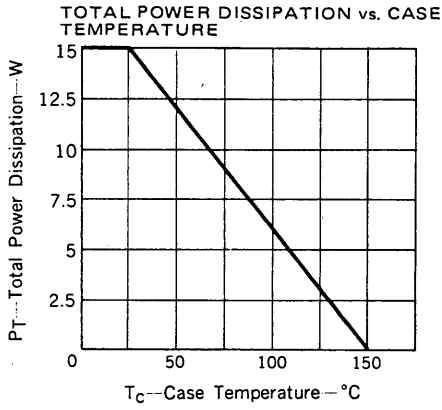

SWITCHING TIME (t_{on} , t_{stg} , t_f) TEST CIRCUIT

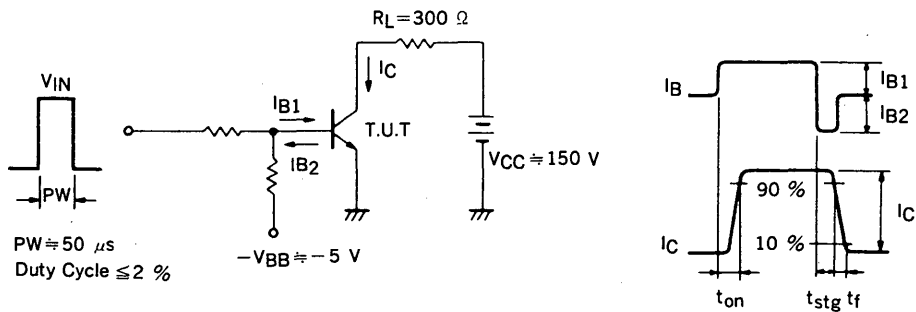

This datasheet has been download from:

www.datasheetcatalog.com

Datasheets for electronics components.